BA SHEV-3 ST4-3140 EN 1.1



sample picture!

Table of Contents

1. In General	4
1.1. Foreword to this manual	4
1.2. Product description	4
1.3. Technical information	5
1.3.1. Power supply information	5
1.3.2. Output information motor channels	5
1.3.2.a. Output-impulse load	5
1.3.3. Connection information emergency switch (HE 080 / HE 082 & HE 081)	5
1.3.4. Connection information fire alarm system (FAS)	6
1.3.5. Connection information smoke detector (RM 3000 / RM 2860)	6
1.3.6. Connection information wind-, rain-detector (WTS)	6
1.3.7. Connection information ventilation switch	6
1.3.8. Connection information free input I	6
1.3.9. Connection information volt free contacts "NO /C / NC"	6
1.3.10. Mechanical features	7
1.3.11. Connection and operation	7
1.3.12. Installation and environmental requirements	7
1.3.13. Registrations and certificates	7
1.3.14. Control time of analog- digital-input	7
1.3.15. Technical information lead acid battery	7
1.4. Functional description	8
1.4.1. Power supply	8
1.4.2. Emergency power supply	8
1.4.3. Control electronics	8
1.4.3.a. The control of the I/V-charge	8
1.4.3.b. The monitoring of the monitor input for sequence control (main-/ emergency-power supply operation)	9
1.4.3.c. The inspection of monitored functions (detection loops, fuse, overload etc.)	9
1.4.3.d. The activation of the load relay	9
1.4.3.e. The activation of the volt-free contacts	9
1.4.3.f. The activation of the operational status indicators (OK, FAILURE and SHE)	9
1.5. Functions	9
1.5.1. Ventilation function	9
1.5.2. Gap ventilation	11
1.5.2.a. Programming sequence gap ventilation	11
1.5.3. Automatic ventilation CLOSED (time-dependent)	11
1.5.3.a. Programming sequence automatic ventilation CLOSED	11

Table of Contents

1.5.4. Dead man function	12
1.5.5. Safe closing/opening during emergency power operation	12
1.5.6. Wind- / rain detector (WTS)	12
1.5.7. Re-triggering function (blockade)	12
1.5.8. SHE-switch reset function	12
1.5.9. Fire-alarm closing	12
1.5.10. FAS auto reset function	13
1.6. External readout of messages	13
2. Safety Regulations	15
3. Figures	16
4. Assembly	18
4.1. Wire lengths	21
5. Start UP	22
6. Fault Finding	24
6.1. Error messages	25
6.2. Troubleshooting	26
6.2.1. Checking voltages	27
6.2.2. Checking loop current	27
6.2.3. Checking power supply (230 V AC 50 Hz)	27
6.2.4. Checking ventilation switch connection	28
6.2.5. Checking wind- / rain detector connection	28
6.2.6. Checking motor connection (24 V DC)	29
6.2.7. Checking main emergency button (HE 080 / HE 082)	29
6.2.8. Checking smoke detector connection	31
6.2.9. Checking output for an on-site SHE release contact (for example Fire alarm)	32
6.3. FAQ — Frequently Asked Questions	33
7. Care and Maintenance	34
7.1. Environmental note	34
7.2. Repair and exchange	34
7.3. Warranty terms	34
8. Appendix	35
8.1. Manufacturer's declaration	35
8.2. EC manufacturer's declaration (distributor)	35
8.3. Company addresses	35
8.3.1. Germany	35
8.3.2. Switzerland	35
8.3.3. Hungary	35

In General

1. In General

1.1 Foreword to this manual

This manual has been created for the purposes of proper operation, installation and maintenance by trained, experienced specialist personnel (e. g. mechatronics engineer or electrician) and / or specialist personnel with knowledge involving the installation of electrical devices.

Read the operating manual carefully and follow the prescribed sequence. Retain the operating manual for later use / maintenance. Please precisely observe the pin assignment, the minimum and maximum performance data (see "Technical data") and the installation instructions. Incorrect usage or improper operation / assembly can cause the loss of system functions and result in damage to property and / or persons.

You will find the following symbols in this manual:



INFO

This information provides you with additional tips!



ATTENTION

This warning draws your attention to potential dangers for the product!



DANGER

This warning draws your attention to possible risks to your life or health!



ENVIRONMENTAL NOTE

This warning draws your attention to potential dangers for the environment!

- This is how operating procedures are identified.
- ↘ Consequences are represented this way.
- *Buttons* or *switches* to be activated are indicated in italics.
- "Displays" are placed in quotation marks.

1.2 Product description

The SHEV[®] 3 (Smoke and Heat Exhaust Ventilation) represents the compact control panel system in the smoke and heat exhaust range. Mainly staircases enclosures are fitted with the use of SHEV[®] 3.

The electric control panel SHEV[®] 3 is a compact device in a plastic housing (optional varieties are displayed in the product catalogue). It contains power supply, emergency power supply and the total operating and control electronics for the operation of 24 V DC-actuators for window and smoke exhaust flaps. The SHEV[®] 3 controls the connected actuators in case of fire, as well as for daily ventilation. The ventilation function also serves as a regular performance check of the Smoke and Heat Exhaust (SHE) equipment. During a power failure, the emergency power supply ensures the performance of the SHE-equipment for at least 72 hours. The connection lines for SHE-switch, smoke detector, Fire Alarm System (FAS) and actuators are monitored. The housing is lead-sealable.

Smoke and heat exhaust equipment are part of facilities technical structural fire prevention. Human lives can be saved with the installation of SHE-equipment. The necessity is therefore embedded by law in the national building regulations. The building permit authority decides if and in which form this legal requirement must be met. Prior to the installation, please check if the dimensions of the SHE-equipment are conform to the regulatory specifications to achieve a satisfactory functionality of the equipment. Through manual (switch) or automated (smoke detector / heat detector) release of the smoke and heat exhaust, actuators or fitting actuators are activated, designated vents in the wall or roof area to enable the smoke extraction.

Sufficient supply air is arranged by simultaneously opening windows or doors in the lower range of the building from which smoke is extracted. Fire gasses and smoke can escape through the smoke vents in the upper range of the building. This allows people who are still in the property, to leave in a smoke free zone of the building. At the same time, the improved visibility will aid the rescue efforts and fire fighting operation of the rescue workers.

In General

1.3 Technical information

1.3.1 Power supply information

Nominal voltage:	230 V AC
Acceptable voltage range:	195 V to 264 V AC
Power consumption ¹ :	0.56 A
Min. series fuse (on site):	≥ C 16 A
Connected load:	103 VA
Inrush current:	approx. 10 A
Frequency range:	47 Hz to 63 Hz
Main fuse: (internal)	Fuse characteristic: Type T 1.25 A
Power supply line cross section:	at least 1.5 mm ²
Clamp format:	0.5 mm ² - 2.5 mm ²

1. Power consumption during maximum load of the supply system.

1.3.2 Output information motor channels

Duty cycle (D):	30%
Output voltage mains operation (nominal):	24 V DC
Acceptable voltage range (mains operation):	23.0 V DC to 24.5 V DC
Output voltage (battery operation (nominal):	24 V DC
Acceptable voltage range (battery operation):	21 V DC to 28.6 V DC
Output current (I_{out}) (short-term oper- ation) ¹ : ($I_{out}=I_{mot1}+I_{mot2}$)	3 A
Power output (non-stop operation):	50 W
Power output (short-term operation):	73.5 W
Output fuse for actuators:	Fuse characteristic: Type T 3.15 A
Ripple of the output voltage ($0 A < I_{out} < 3 A$):	≤ 300 mVpp
Power outage bridge-over time ² :	10 ms
Clamp format:	0.5 mm ² - 2.5 mm ²

1. Overload duration (see Figure 1: "Chart output-impulse load").
2. Input voltage 195 V AC; load current 3 A.

1.3.2.a Output-impulse load

The SHEV[®] 3 can be, subject to time, loaded in accordance with the following chart. The chart represents the 20 V DC output voltage limit. The output voltage should not fall below a value of 20 V DC. Therefore the impulse load can be kept in the lower quadrant of the curve (see Figure 1: "Chart output-impulse load").

Figure 1: Chart output-impulse load

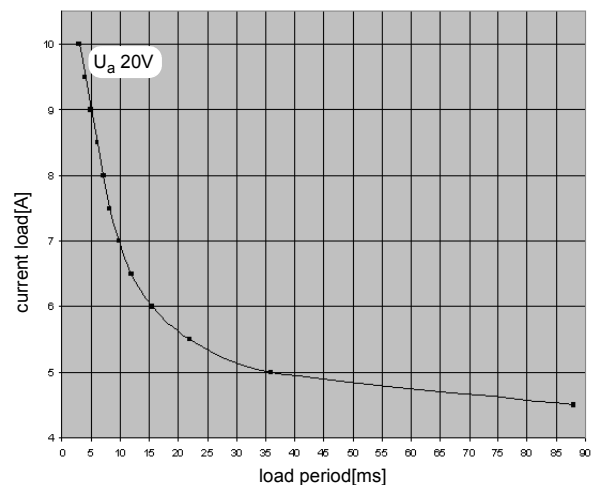

1.3.3 Connection information emergency switch (HE 080 / HE 082 & HE 081)

Maximum number of main emergency switch (e. g. HE 080 / HE 082)	1	
Maximum number of ancillary emergency switch (e. g. HE 081)	7	
Output voltage range (B1):	Clamp 7	17.5 V DC to 18 V DC
Current carrying capacity (B1):	Clamp 7	max. 120 mA
Monitoring current (OK-range)	Clamp 7	100 µA to 5 mA
Output voltage range (OK):	Clamp 1	21 V DC to 28.2 V DC
Output voltage range (Y):	Clamp 2	21 V DC to 28.2 V DC
Output voltage range (M):	Clamp 3	21 V DC to 28.2 V DC
Input voltage range (RA):	Clamp 6	15 V DC to 30 V DC

In General

Input voltage range (RZ):	Clamp 5	15 V DC to 30 V DC
Current carrying capacity (OK):	Clamp 1	max. 80 mA
Current carrying capacity (Y):	Clamp 2	max. 80 mA
Current carrying capacity (M):	Clamp 3	max. 80 mA

1.3.4 Connection information fire alarm system (FAS)

Output voltage range (B3):	Clamp 28	17.5 V DC to 18 V DC
Current carrying capacity (B3):	Clamp 28	max. 120 mA
Monitoring current (OK-range)	Clamp 7	100 µA to 5 mA
Reset time after SHE-reset (by disconnecting from mains B3):	Clamp 28	3 sec.
Input voltage range (RA):	Clamp 30	15 V DC to 30 V DC

1.3.5 Connection information smoke detector (RM 3000 / RM 2860)

Maximum number:		8 x RM 3000 6 x RM 2860
Output voltage range (B2):	Clamp 25	17.5 V DC to 18 V DC
Current carrying capacity (B2):	Clamp 25	max. 120 mA
Monitoring current (OK-range)	Clamp 7	100 µA to 5 mA
Reset time after SHE-reset (by disconnecting from mains B2):	Clamp 25	3 sec.
Input voltage range (RA):	Clamp 27	15 V DC to 30 V DC

1.3.6 Connection information wind-, rain-detector (WTS)

Maximum number:		1
Output voltage range (E):	Clamp 9	23.0 V DC to 24.5 V DC
Current carrying capacity (E):	Clamp 9	max. 150 mA
Input voltage range (LZ):	Clamp 10	15 V DC to 30 V DC

1.3.7 Connection information ventilation switch

Output voltage range (E):	Clamp 22	23.0 V DC to 24.5 V DC
Current carrying capacity (E):	Clamp 22	max. 15 mA
Input voltage range (A):	Clamp 24	15 V DC to 30 V DC
Input voltage range (Z):	Clamp 23	15 V DC to 30 V DC

1.3.8 Connection information free input I

Input voltage range (I):	Clamp 16	15 V DC to 30 V DC
--------------------------	----------	--------------------

1.3.9 Connection information volt free contacts "NO / C / NC"

Voltage capacity of switching contact 1 (C - NO):	Clamp 32 on Clamp 31	max. 30 V DC
Voltage capacity of switching contact 1 (C - NC):	Clamp 32 on Clamp 33	max. 30 V DC
Voltage capacity of switching contact 2 (C - NO):	Clamp 35 on Clamp 34	max. 30 V DC
Voltage capacity of switching contact 2 (C - NC):	Clamp 35 on Clamp 36	max. 30 V DC
Voltage capacity of switching contact 1 and 2 (C - NO resp. C - NC) – ohmic load:		max. 2 A DC
Switching power:		60 W / 62.5 VA

In General

1.3.10 Mechanical features

Size Standard (w x h x d):	254 x 180 x 111 mm
Size "Jumbo" (optional) (w x h x d):	361 x 254 x 111 mm
Weight (incl. battery):	4.40 kg
Protection type:	IP66 ¹ acc. EN 60 529
Housing:	Polystorol ² Halogen-free
Colour:	grey (resembling RAL 7035)
Protection class:	Ⅲ ³

1. With the respective use of IP66 cable glands.
2. Other materials optional.
3. To achieve a higher EMC stability the protective conductor is used as functional electrical conductor and should be connected.

1.3.11 Connection and operation

Connection:	See Figure 6: "Wiring diagram total (simplified representation)" on page 19.
Terminal clamps:	Tension spring clamps 0.5 mm ² - 2.5 mm ²
Switching off the actuators in any position:	yes ¹
Timing according to DIN EN 12101-9:	yes (see chapter 1.5.7 "Re-triggering function (blockade)" on page 12)
Maximum wire length between control unit and actuator:	See chapter 4.1 "Wire lengths" on page 21.
Opening-/closing process:	Pole reversal of the operating voltage
Pause time during direction change:	200 ms
Maintenance:	See chapter 7. "Care and Maintenance" on page 34.

1. Only during ventilation operation.

1.3.12 Installation and environmental requirements

Operating temperature ¹ :	-5 to 40 °C
Storage temperature ¹ :	-5 to 40 °C
Suitable for outdoor installation:	No

1. This temperature range applies to all components of the SHEV[®] 3-System (including battery).

1.3.13 Registrations and certificates

EN compliant:	As per EMC directive 2004 / 108 / EC and the low-voltage directive 2006 / 95 / EC
Additional registrations, certificates:	ISO 21927-9 prEN 12101-9 DIN EN 12101-10
Classification as per EN 12101-9:	Class D
Classification as per EN 12101-10:	Class A
Environmental class as per EN 12101-10:	1

1.3.14 Control time of analog- digital-input

Input digital (RZ, RA, LZ, Z, A):	500 ms
Input analog (B1, B2, B3) during mains operation:	500 ms
Input analog (B1, B2, B3) during emergency power operation:	2500 ms

1.3.15 Technical information lead acid battery

Maintenance-free lead acid battery	
Dimensions (w x h x d):	171 x 33 x 60 mm
Weight incl. installation plate:	2.20 kg
VdS registration:	G101139
Output voltage per battery:	10.5 V DC to 14.1 V DC
Output voltage total (series connection):	21.0 V DC to 28.2 V DC
Rated capacity (total):	2.3 Ah
Service life:	approx. 4 years

In General

1.4 Functional description

The SHEV[®] 3 (Smoke and Heat Exhaust Ventilation) represents the compact control panel system in the SHE range. In the standard version, it is housed as a compact assembly group in a single board system in a surface-mounted housing. Mainly staircases enclosures are fitted with the use of SHEV[®] 3.

The requirements involved are the connection option of all necessary tripping devices such as:

- smoke detector,
- SHE-emergency button,
- fire alarm-signal

and the control of SHE-actuators.

The SHEV[®] 3 essentially consists of three components:

1. power supply
2. emergency power supply
3. control electronics

1.4.1 Power supply

If the SHEV[®] 3 is connected to the mains and supplies the necessary power from the mains, then this is considered normal operations (mains operation). The power supply is designed in such a manner that it can meet the power demand of the control technology, the battery charging and can provide power for the connected actuators. It is built as a switching power supply.

The power supply is sustained short circuit-proof, sustained no-load running-proof and is safeguarded by a complying fuse. The power supply is exclusively cooled by natural air cooling.

1.4.2 Emergency power supply

The emergency power supply of the SHEV[®] 3 is ensured by two 12 V lead acid batteries, which are series connected.

During emergency power operation, these take over the power supply of the control electronics and the connected actuators. The battery capacity is adjusted to the power supply output range and is regulated by the individual discharge phases (VdS 2593 / DIN EN 12101-10). The switching between the two operation states is automated. The load output for the SHE - actuators is represented by two heavy load relays that operate using the pole reversal technique to ensure the OPEN / CLOSED control. The outputs are protected by a corresponding fuse.

During the emergency power operation, appropriate currents are to be supplied in various phases.

Upon conclusion of this discharge, the discharge threshold voltage and the under-voltage limit should not be reached.

1.4.3 Control electronics

The complete control of the SHEV[®] 3 is assumed by a microcontroller.

The control functions consist of:

- a. the control of the I/V-charge,
- a. the monitoring of the monitor input for sequence control (mains-/emergency power supply operation),
- a. the inspection of the monitored functions (detection loops, fuse, overload, etc)
- a. the activation of the load relay
- a. the activation of the volt-free contacts
- a. the activation of the operational status indicator (OK, ERROR and SHE)

1.4.3.a The control of the I/V-charge

The charge of the lead acid backup-battery is accomplished in the form of a I/V-charge. This means that the charging current is bound to a constant current. If the battery voltage reaches the charge threshold voltage, then this voltage will be limited, by reducing the charging current. According to the manufacturer's data, the charging voltage is influenced by the ambient temperature, which means that the charge threshold voltage decreases when the ambient temperature increases, the reverse applies accordingly when the ambient temperature drops. The charging circuit is designed in such a way that 80% of the battery capacity can be charged within 24 hours, after the battery was discharged at its discharge threshold voltage. This conforms to the DIN EN 12101-10 requirement. To inspect the condition of the connected battery, the charge is turned off for a short time in intervals of approximately 8 minutes. The condition of the battery is inspected during this charging break. Meanwhile for example a disconnected battery will be detected and indicated as an error. Should the battery pair fault due to the cells becoming high-ohmic, then the control will also detect this and inform the facility operator with a fault message at the SHE-switch (yellow LED).

The detailed fault message can be read-out via service-cable (USB-200) and SIMON-Link.

In General

1.4.3.b The monitoring of the monitor input for sequence control (main-/ emergency-power supply operation)

If there is a power outage or under-voltage of the power supply, or a power supply failure, then the SHEV[®] 3 switches to the emergency power supply. This is done with the help of monitoring (monitor function). Thereby the control electronics can switch to emergency power operation at an early stage and avoid an output voltage disruption.

1.4.3.c The inspection of monitored functions (detection loops, fuse, overload etc.)

The control electronics monitor the tripping devices SHE-switch, smoke detector and FAS with a no-load current surveillance. This means that a permanent no-load current flows over the tripping devices. This is secured by the terminating resistors in the last tripping device. Once the closed-circuit current leaves a certain range of values (current window), the relevant detection line will trigger the SHE-state. To get to the normal operation from the SHE-state, a reset must be executed (see chapter 1.5.8 "SHE-switch reset function" on page 12).

1.4.3.d The activation of the load relay

All SHEV[®] 3 outlets are equipped with an overload protection. During emergency power operation all relays de-energize after 3 minutes (maker opens again and breaker closes) (see chapter 1.5.5 "Safe closing/opening during emergency power operation" on page 12).

1.4.3.e The activation of the volt-free contacts

During emergency power operation all relays de-energize (maker opens again and breaker closes). Depending on wiring, "volt-free contact" can be output by the error relay (see Table 2: "Matrix signal relay (Contact 1, Contact 2)" on page 14).

1.4.3.f The activation of the operational status indicators (OK, FAILURE and SHE)

The SHEV[®] 3 has three operational status indicators on the control board to display the actual operation mode (see chapter 6.1 "Error messages" on page 25).

- The green LED indicates mains operation.
- The yellow LED serves as status or fault indicator.
- The red LED indicates SHE - alarm.

1.5 Functions

1.5.1 Ventilation function

In order to use the SHEV[®] 3 for ventilation, a ventilation OPEN / CLOSED switch can be connected. Activating both switches (OPEN / CLOSED) simultaneously effectuates the function STOP. The ventilation function can only be controlled during mains operation.

The switch can be allocated with various action behaviours. The options are displayed in the following table and can be configured with the selector switch SW1 on the SHEV[®] 3 board. The directions are operated by using the directional switches OPEN / CLOSED (signalling time more than 500 ms) (see Table 1: "Matrix ventilation switch" on page 10).

In General

Figure 2: DIP switch SW1

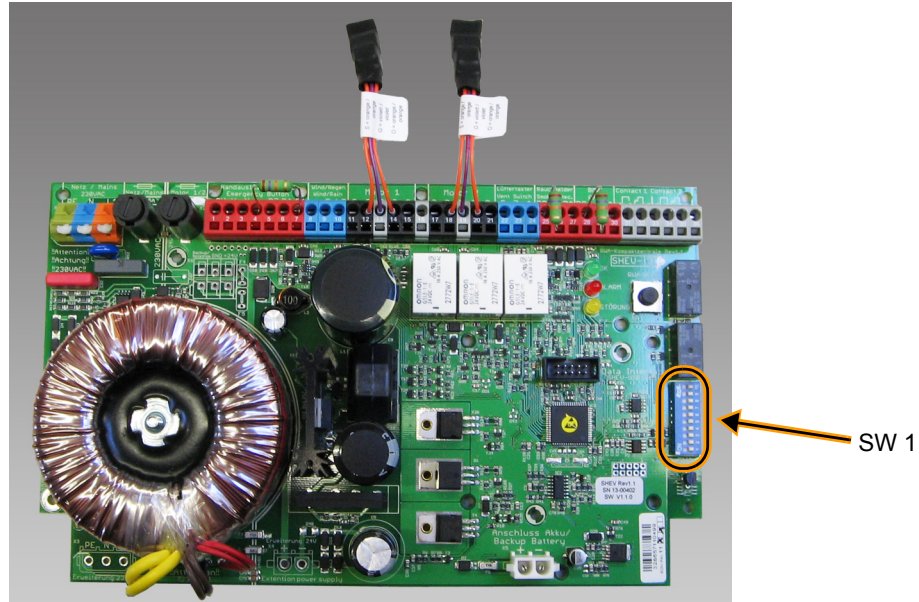

Table 1: Matrix ventilation switch

Con-figuration	SW1 - 1	SW1 - 2	SW1 - 3	SW1 - 4	Configuration ventilation switch	Remarks
1	OFF	OFF	OFF	OFF	Continuous OPEN/CLOSED	Delivery state
2	ON	OFF	OFF	OFF	OPEN and CLOSED with dead man function	Dead man function – the actuator will run as long as the vent button is pressed in OPEN or CLOSE.
3	OFF	ON	OFF	OFF	OPEN with dead man function / CLOSED without	
4	ON	ON	OFF	OFF	OPEN without dead man function / CLOSED with	
5	OFF	OFF	ON	OFF	Limited ventilation	In case of ventilation the actuators open for the programmed time.
6	ON	OFF	ON	OFF	Automatic ventilation CLOSED	The system closes automatically after the expiration of the time.
7	OFF	ON	ON	OFF	Limited ventilation with automatic ventilation CLOSED	Combination of configuration 5 and 6.
8	OFF	OFF	ON	ON	Programming mode for gap ventilation	See chapter 1.5.2.a “Programming sequence gap ventilation” on page 11.
9	ON	OFF	ON	ON	Programming mode for automatic ventilation closed	See chapter 1.5.3.a “Programming sequence automatic ventilation CLOSED” on page 11.
10	ON	ON	ON	ON	Ventilation switch closed	Ventilation disabled

In General



ATTENTION

Only the implemented DIP-switch configurations are proven. The unimplemented selection combinations of the DIP-switch are undefined. This means that they deactivate the ventilator switch, except for the STOP function.

1.5.2 Gap ventilation

Configuration 5 or 7 (see Table 1: "Matrix ventilation switch" on page 10).

The limited ventilation and stroke limiting are activated by operating the ventilator switch in OPEN direction and enables the user to operate the actuator automatically for a defined time. The function is time controlled and factory-set to 3 seconds.

The limited ventilation time can be modified afterwards by the user between min. 3 seconds and max. 255 seconds. The factory setting will be applied if the time set by user is outside this range.

1.5.2.a Programming sequence gap ventilation

Configuration 8 (see Table 1: "Matrix ventilation switch" on page 10).

Prior to the start of programming, the system must display the following state:

- Operation state OK = mains operation;
 - LED "Alarm" and LED "Fault" are off;
 - Smoke vents are closed.
- Configuration 8 (see Table 1: "Matrix ventilation switch" on page 10) select DIP-switch *SW1*.
- The programming mode is indicated by the flashing of the yellow LED.
- Start the programming mode by operating the *ventilator switch* in OPEN direction.
- Once the vents reach the desired position (running time between 3 and 255 seconds are possible; factory setting: 3 seconds), end the programming by activating STOP (OPEN and CLOSED simultaneously) at the *ventilator switch*.
- The programming mode is quit by selecting an operation configuration (5 or 7) at the DIP-switch *SW1*.

- The end of the programming mode is indicated by the disappearance of the yellow LED and the limited ventilation time is stored permanently

Should the limited ventilation time not have the desired value: See chapter 6. "Fault Finding" on page 24.



ATTENTION

The dead man function in the OPEN direction is inactive during limited ventilation.

1.5.3 Automatic ventilation CLOSED (time-dependent)

Configuration 6 or 7 (see Table 1: "Matrix ventilation switch" on page 10).

Enables the user to close the vents automatically after ventilation. The ventilation function is time controlled and is factory-set to 10 minutes.

The ventilation time can be changed afterwards by the user to min. 10 minutes and max. 18 hours. The factory setting will be applied if the time set by user is outside this range.

1.5.3.a Programming sequence automatic ventilation CLOSED

Prior to the start of programming, the system must display the following state:

- Operation state OK = mains operation;
- LED "Alarm" and LED "Fault" are off;
- smoke vents are closed.

➤ **Configuration 9** (see Table 1: "Matrix ventilation switch" on page 10).

➤ The programming mode is indicated by the flashing of the yellow LED.

➤ Start the programming mode by operating the *ventilator switch* in OPEN direction.

➤ If the vents have been open for the desired time (ventilation time between 10 minutes and 18 hours; factory setting: 10 minutes), end the programming by activating CLOSED at the *ventilator switch*.

➤ The programming mode is quit by selecting an operation configuration (6 or 7) at the DIP-switch *SW1*.

➤ The end of the programming mode is indicated by disappearance of the yellow LED and time is stored permanently.

In General

If the limited ventilation time does not have the desired value: See chapter 6. "Fault Finding" on page 24.

1.5.4 Dead man function

Configuration 2, 3 or 4 (see Table 1: "Matrix ventilation switch" on page 10).

The dead man function is a security function, allowing the actuators to go in the respective direction as long as the respective direction switch is operated. The actuators immediately stop once the switch is released.



ATTENTION

With the setting dead man in direction OPEN/CLOSED, the vents are controlled permanently by the SHE-alarm when there is a triggering. The alarm function overrides the dead man function.

The dead man function is deactivated and over modulated by the WTS when a wind-/ rain detector is connected to the SHEV[®] 3.

1.5.5 Safe closing/opening during emergency power operation

During mains operation, the SHEV[®] 3 is controlled with the ventilation commands OPEN, CLOSED, CLOSED-WTS, these commands are maintained for three minutes after a switch to emergency power operation. Thereafter, "S" and "O" becomes voltage-less.

This function enables the user to safely close and open the system during a switch in the emergency power operation.

If the SHEV[®] 3 does not have the desired ventilation performance: See chapter 6. "Fault Finding" on page 24..

1.5.6 Wind- / rain detector (WTS)

The wind- / rain detector allows the user to close the for ventilation opened openings / windows, caused by weather influences, automatically. A permanent CLOSED command is generated after the wind- / rain detector is triggered, that can only be overridden by SHE-functions, this means the SHE-state always has the highest priority.

1.5.7 Re-triggering function (blockade)

The SHEV[®] 3 complies to the standards of the DIN EN 12101-9. The re-triggering function generates the complete time programme as required. This means that after a SHE triggering, the actuators are actuated 15 times in OPEN-direction. A renewed start attempt is carried with the previous short closing for 3 seconds in CLOSED-direction with intervals of 2 minutes. A waiting time is observed with each directional change. After 30 minutes have lapsed the control direction remains OPEN.

This function is for the safe opening of the smoke vent in case these are blocked by, for example, ice or snow and cannot be opened first time around.

1.5.8 SHE-switch reset function

The SHE-message can be reset by the *SHE-switch*. Only the SHE-message is reset when the *RESET-switch* is operating the first time.

If a SHE-alarm is present at detection loop 2 or 3 at this stage, then this message is blocked out for 3 seconds when the RESET switch is operated. Additionally, the detection loops 2 and 3 are switched off for this same amount of time.

By operating the *RESET-switch* twice, the smoke vents will close.

With a setting of the ventilation function dead man in OPEN / CLOSED and dead man CLOSED (configuration 2, 3 or 4) (see Table 1: "Matrix ventilation switch" on page 10) the smoke vents close for as long as the *RESET-switch* is operating the second time. The smoke vents close automatically in all other settings.

1.5.9 Fire-alarm closing

The priority function enables the user to change the manner of action of the smoke vents during a triggering by the fire alarm.

The smoke vent should be directed in the direction CLOSED during a triggering at the detection loop 3 (fire alarm). The ventilation function is blocked by the fire alarm during a triggering. The triggering is not shown as an alarm or fault. In this state, the smoke vent are only driven in OPEN direction at the SHE-switch by a SHE-smoke detector triggering or a SHE-triggering. The SHE-switch reset function remains preserved.

In General

When the priority function “fire alarm closes” is used, the fire alarm-contact must be connected to detection loop 3:

- During wire break monitoring as breaker-contact between B3 and minus (-), with terminating resistor at fire alarm-contact.
- For undesired wire break monitoring as breaker-contact at RA port.

This function can be activated with the use of a selector switch SW1 in the SHEV® 3. If the DIP-switch 9 at SW1 is turned ON, then the FAS-alarm signal with manner of action smoke vents in CLOSED direction is selected. If the switch is turned OFF, then the priority is reversed and the smoke vents are navigated in the OPEN direction when there is a fire alarm signal.



ATTENTION

At the time of a triggering or disconnection and simultaneously setting FAS closes, a permanent CLOSED command is generated which is not visualized and is solely over modulated by SHE. The ventilation function will be automatically blocked. The generated CLOSED-command can be undone by operating the RESET-switch twice (see chapter 1.5.8 “SHE-switch reset function” on page 12). Requirement: No queuing FAS-signal.



INFO

The FAS CLOSED-command can be visualized with an indication relay (see Table 2: “Matrix signal relay (Contact 1, Contact 2)” on page 14).



ATTENTION

In the setting dead man in OPEN / CLOSED and dead man CLOSED, the function “FAS closes” is not active! Since no alarm and no fault is displayed in the event of a triggering of the detection loop in the setting “FAS closes”, the visualization that the smoke vents are closed by the SHE cannot be seen. This means that the smoke vents remain directed in CLOSED and this status cannot be over modulated by the ventilator switch! Additionally, this setting in emergency power operation results in the SHEV® 3 not switching into the energy savings mode!

In the setting “FAS closes”, it is recommended to use the setting FAS auto reset instead of the DIP-switch at SW1!

The advantage of this is that upon the cessation of the triggering by the FAS, the FAS-alarm is automatically cancelled and the ventilation function is again available through the ventilation switch.

Furthermore, upon cancellation of the alarm in emergency power operation the SHEV® 3 switches to the energy saving mode.

1.5.10 FAS auto reset function

Upon the triggering by fire alarm-contact (High Signal or disconnection of B1), the message is cancelled again by the FAS-reset function when the signal is changed or the disconnection is lifted. The function can be switched on or off via the DIP-switch 10 at SW1. If the DIP-switch is set on ON, then the FAS Auto-Reset is activated, if the switch is set on OFF, then the function is inactive.

When the FAS-Auto Reset function is utilized, the FAS-contact must be connected to the detection loop 3.

1.6 External readout of messages

The SHEV® 3 is equipped with two volt-free relays or contacts to redirect fault messages. The user can select the allocation of the message using a DIP-switch 5 - 8 at SW1 on the SHEV® 3 board (see Table 2: “Matrix signal relay (Contact 1, Contact 2)” on page 14).

In General

Table 2: Matrix signal relay (Contact 1, Contact 2)

SW1 - 5	SW1 - 6	SW1 - 7	SW1 - 8	Allocation contact 1	Allocation contact 2	Remarks
OFF	OFF	OFF	OFF	Message SHE released (Alarm)	Fault (see chapter 6.1 "Error messages" on page 25)	Delivery state
ON	OFF	OFF	OFF	Message SHE released (Alarm)	Actuators triggered in OPENING-direction	
OFF	ON	OFF	OFF	Message SHE released (Alarm)	Actuators triggered in CLOSING-direction	
ON	ON	OFF	OFF	Message SHE released (Alarm)	Wind- /rain detector "CLOSING active"	
OFF	OFF	ON	OFF	Message SHE released (Alarm)	OK	Power supply ok and no wire break on motor line 1 / 2
ON	OFF	ON	OFF	Fault (see chapter 6.1 "Error messages" on page 25)	Actuators triggered in OPENING-direction	
OFF	ON	ON	OFF	Fault (see chapter 6.1 "Error messages" on page 25)	Actuators triggered in CLOSING-direction	
ON	ON	ON	OFF	Fault (see chapter 6.1 "Error messages" on page 25)	Wind- /rain detector "CLOSING active"	
OFF	OFF	OFF	ON	Fault (see chapter 6.1 "Error messages" on page 25)	OK	Power supply ok and no wire break on motor line 1 / 2
ON	OFF	OFF	ON	Actuators triggered in OPENING-direction	Actuators triggered in CLOSING-direction	
OFF	ON	OFF	ON	Actuators triggered in OPENING-direction	Wind- /rain detector "CLOSING active"	
ON	ON	OFF	ON	Actuators triggered in OPENING-direction	OK	Power supply ok and no wire break on motor line 1 / 2
OFF	OFF	ON	ON	Actuators triggered in CLOSING-direction	Wind- /rain detector "CLOSING active"	
ON	OFF	ON	ON	Actuators triggered in CLOSING-direction	OK	Power supply ok and no wire break on motor line 1 / 2
OFF	ON	ON	ON	Wind- /rain detector "CLOSING active"	OK	Power supply ok and no wire break on motor line 1 / 2
ON	ON	ON	ON	Message SHE released (Alarm)	Message FAS released (Fire alarm)	

Safety Regulations



ATTENTION

Status messages are not displayed while emergency power operations.

The indication relays are reset to the basic position (break contact closed). Please note the operation / triggering in / while emergency power operations (see chapter 1.4.3.e "The activation of the volt-free contacts" on page 9).



INFO

With configuration of the indication relay with fault / failure the signal of the relay contacts are inverted:
failure ⇒ closing contact opened.
no failure ⇒ closing contact closed.

Possible applications:

OK = closing contact is closed = power supply ok and motor line 1 / 2 ok. (mains monitoring)
OK off = wire break on motor line 1 or 2

2. Safety Regulations

FOR THE SAFETY OF PERSONS IT IS IMPORTANT TO FOLLOW THESE INSTRUCTIONS. THESE INSTRUCTIONS ARE TO BE KEPT AND HANDED TO THE CUSTOMER FOLLOWING INSTALLATION AND COMMISSIONING.



DANGER

The actuating element of switches with an 'off' presetting must be installed in a place with a direct line of sight to the driven part, but away from moving parts. If it is not a key switch, it must be installed at a height of at least 1.5 m and must be inaccessible to the public.



DANGER

Do not allow unauthorised persons (e. g. children) to operate permanently installed control panels. Keep remote controls out of reach of unauthorised persons.



DANGER

Please consider VDE 0833 for hazard alert systems, VDE 0100 for electrical systems, DIN 18232 for SHEV systems, the local fire department regulations, the energy supply company regulations for the mains connection as well as BGV A3 and the BG regulation BGR 232. All relevant national safety regulations and rules apply to the bringing onto the market, installation and commissioning of the equipment outside the country of manufacture (Germany).



DANGER

Free access must be ensured to the energy supplies and electrical control panels of SHEV systems.



DANGER

The sign for the manual release must be attached permanently in the vicinity of its actuating element.

Figures

3. Figures

Figure 3: Block diagram

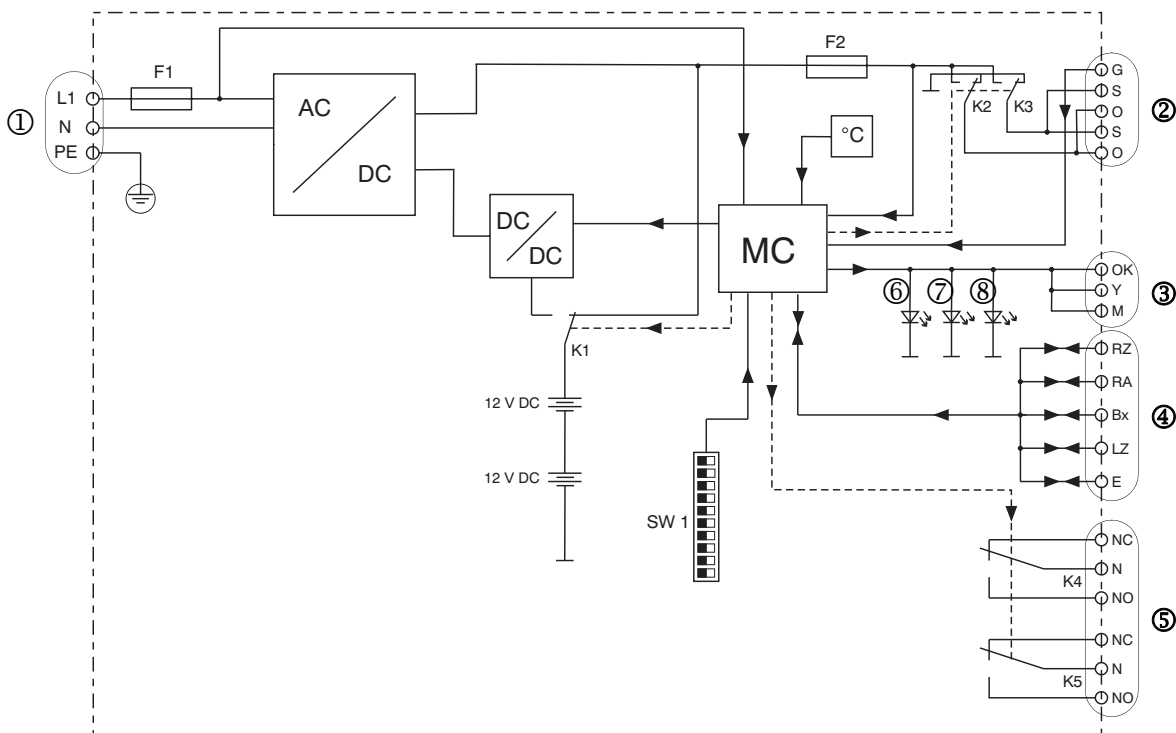









Legend:

- SW 1 DIP switch setting SHEV
- F1 fuse, mains
- F2 fuse, motor
- K2, K3 pole reverse relay
- K4, K5 indication relays
- ① mains
- ② actuator 1 / actuator 2
- ③ messages for switch
- ④ tripping devices
- ⑤ detector signalling contacts
- ⑥ LED "OK"
- ⑦ LED "Alarm"
- ⑧ LED "Fault"

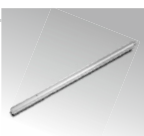
Figures

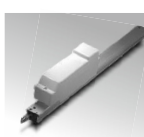
Figure 4: Connection examples

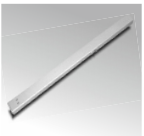
Electrical Control Unit, Type SHEV® 3	Cable Information	SHE-alarm	Item Number	
	e.g. BMK JY (ST) Y - 10 x 0.8 UP		electrical emergency override switch (max. 8 pieces: 1 pcs. Type HE 080/082 and 7 pcs. Type HE 082)	
	e.g. BMK JY (ST) Y - 4 x 0.8 UP		smoke detector Type RM 3000 (max. 8 pieces) or Type RM 2860 (max. 6 pieces)	
	e.g. Y (ST) Y 4 x 0.8 UP/AP	onside different	potential free contact (FAS)	
	Cable Information	Trigger Units Ventilation	Item Number	
	e.g. Y (ST) Y 4 x 0.8 UP/AP		vent switch e.g. Type ST/UP	
	e.g. Y (ST) Y 6 x 0.8 UP/AP		wind- / rain detector Type WTS-892	
	e.g. Y (ST) Y 6 x 0.8 UP/AP		alternatively: rain detector Type WS-890	
	Cable Information	24 V DC Outputs		Item Number
	e.g. NYM-O 4 x ... UP		3 (6*) linear actuator Type EA-L-500-xxx, á 0.95 A max. 3 Amp. (SHEV 3) max. 6 Amp. (SHEV 6)	
e.g. NYM-O 4 x ... UP				
	alternatively: 2 (5*) slit actuator Type EA-L/S á 1.1 A	alternatively: 1 (2*) folding arm actuator Type EA-KL², á 2.6 A	alternatively: 3 (6*) rack and pinion actuator Type EA-SZ, á 1.0 A	
				
	alternatively: 3 (6*) chain actuator Type EA-K, EA-KS, EA-KN á 1.0 A	alternatively: 1 (3*) chain actuator Type EA-K, EA-KS-DUO á 2.0 A		

The information marked with "*" only applies to the SHEV® 6.

Assembly

4. Assembly



DANGER

Mounting may be carried out only by professional personnel (qualified electrician)! All relevant national safety regulations and rules apply to mounting, installation and commissioning.

If the installation is not carried out correctly there is a danger of electrocution. It is essential that you adhere to the applicable safety regulations! Pay attention to the valid installation regulations. Incorrect installation can lead to serious injuries.

The position of installation of the SHEV® 3 is subject to the position of the battery. The batteries can be installed in all positions except overhead.



ATTENTION

The openings of the battery cells (round lid on the top side of the batteries) should not point downwards. As improper care of the batteries will lead to gel leakage from the battery!



ATTENTION

Do not ever connect the battery during installation!

- Mark the position of the drilling holes (see Figure 5: "Fastening points housing").
- Make drilling holes.
- Fasten the SHEV® 3 with four, subsurface suitable screws (screws are not included in the scope of delivery) through the housing bottom.

Figure 5: Fastening points housing

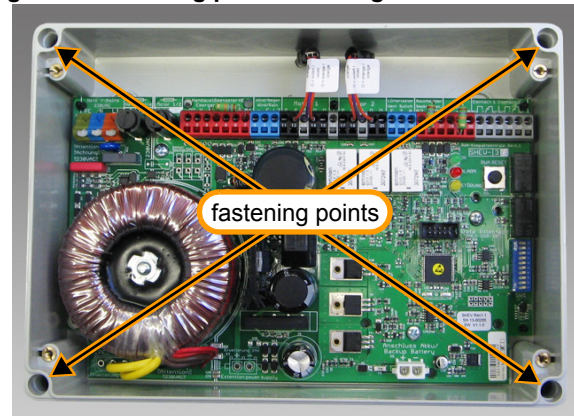

DANGER

Disconnect the power supply cord for all poles from the mains. The connection of the SHEV® 3 must be done volt-free!

- Lead the power supply cords through the prepunched openings.
- Connect cords according to wiring diagram. (see Figure 6: "Wiring diagram total (simplified representation)" on page 19) and the subsequent wiring diagrams.
- Remove the terminating resistors of the SHE-switch, smoke detector and the FAS-contacts from the clamps of the central unit and connect to the triggering devices.



ATTENTION

The indicated protection type IP 66 only remains if the appropriate running of cables resources are employed.

Assembly

Figure 6: Wiring diagram total (simplified representation)

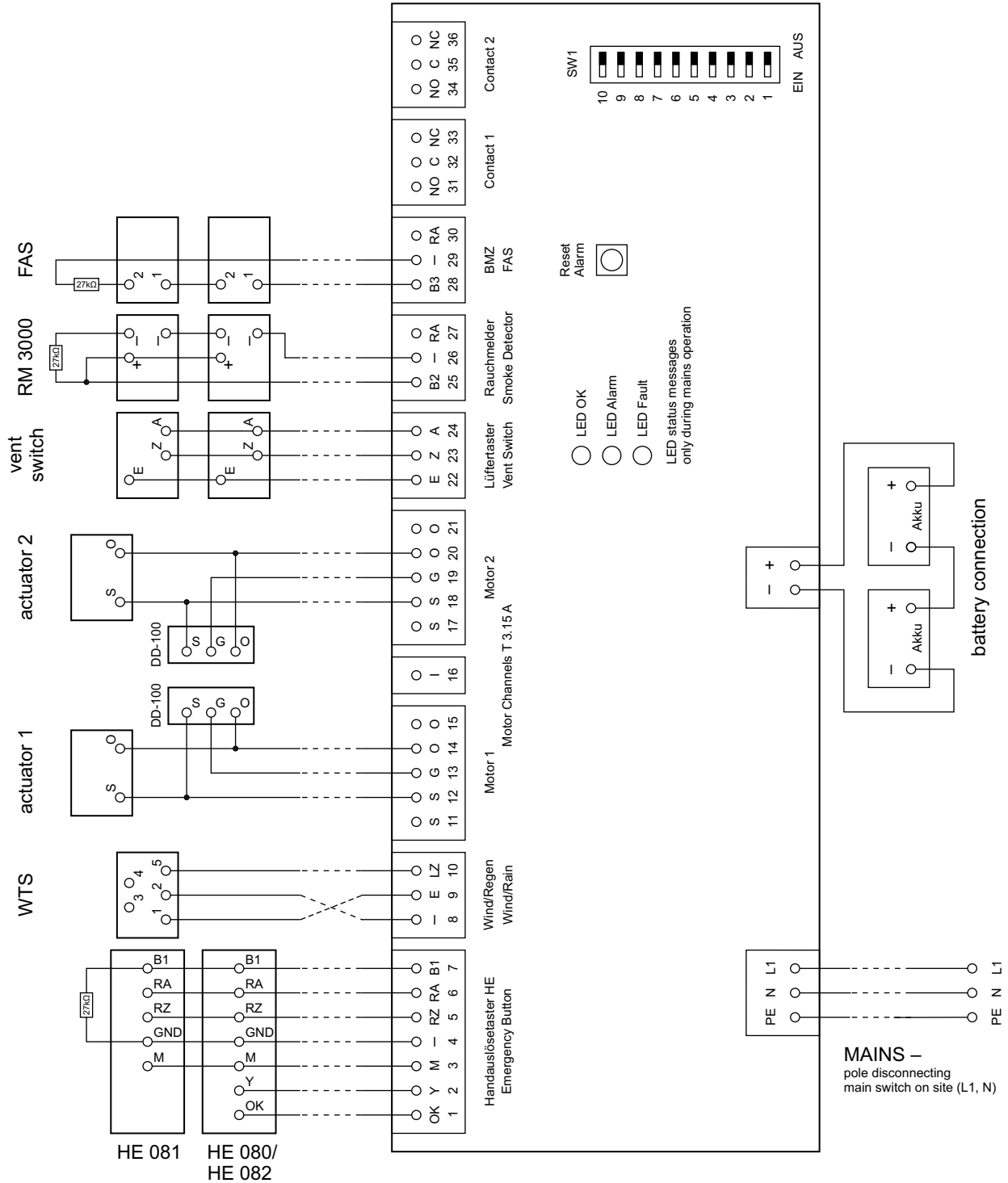

Assembly



ATTENTION

For maintenance purposes install an all-pole mains switch (N, L1) before the SHEV® 3.

Figure 7: Wiring diagram mains

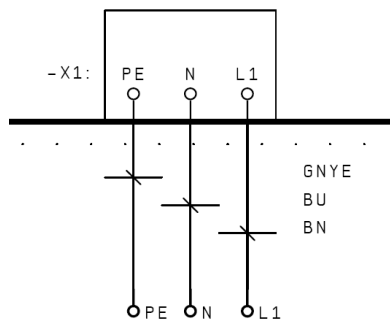

230 V AC / 50 Hz



INFO

The use of shielded wires is recommended for the detection loops. The insulation resistance must display at least 20 MΩ/km. Manufacturer's technical information are to be observed when the wires are laid.

Figure 8: Wiring diagram SHE-switch

terminating resistor at last switch

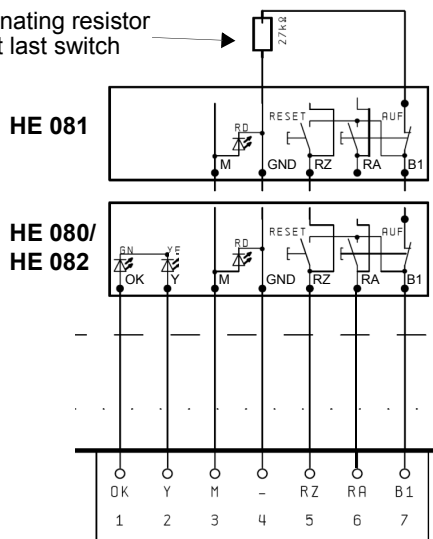

Figure 9: Wiring diagram wind- / rain detector

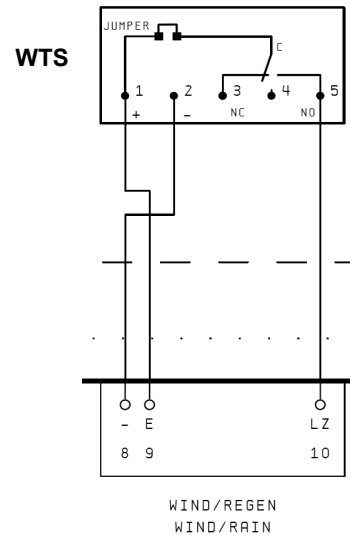
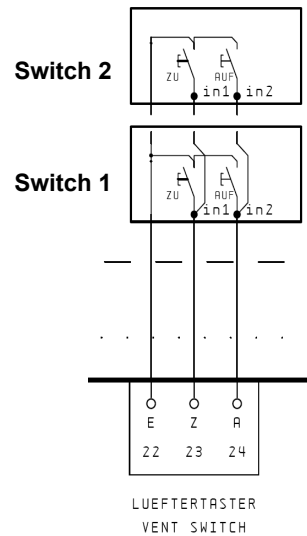

Figure 10: Wiring diagram ventilation switch



Assembly

Figure 11: Wiring diagram smoke detector

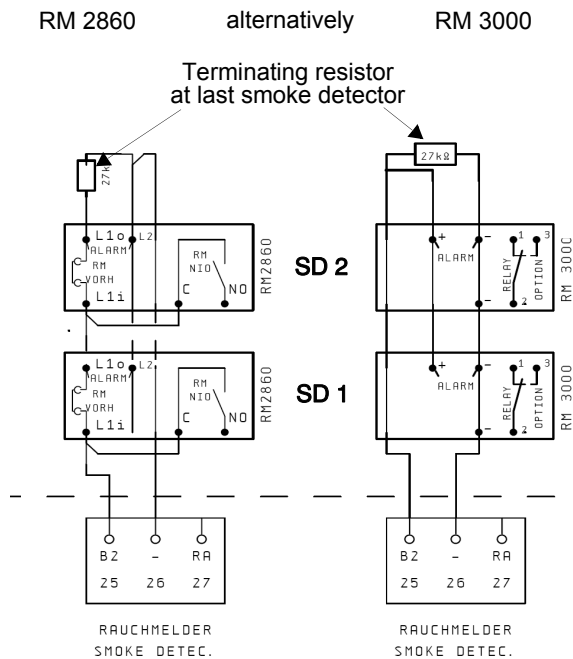

Figure 12: Wiring diagram contact FAS

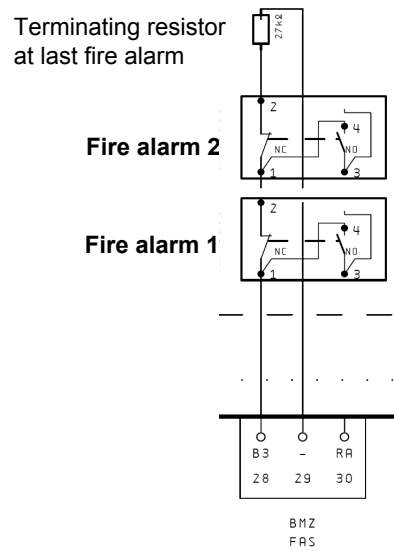
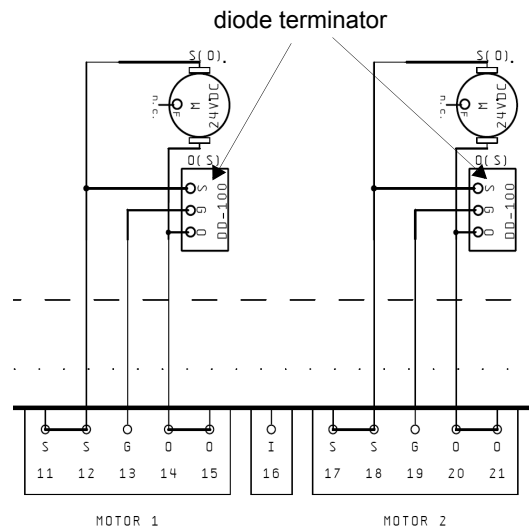

Figure 13: Wiring diagram actuator 1 and actuator 2



4.1 Wire lengths



INFO

Dimension indications (rule of thumb):

Wire cross-section [mm²] := 0.019 x number of motors x power consumption per motor [A] x wire length [m].

The national regulations are valid.

Start UP

5. Start UP



ATTENTION

The battery must only be mounted and connected once the start up of the SHEV[®] 3 is executed successfully and the on-site power supply has been permanently secured.

- Execute start up. Prior to turning on the SHEV[®] 3, you must perform the following visual and functional checks (see Figure 14: "Start up – checklist").

Figure 14: Start up – checklist

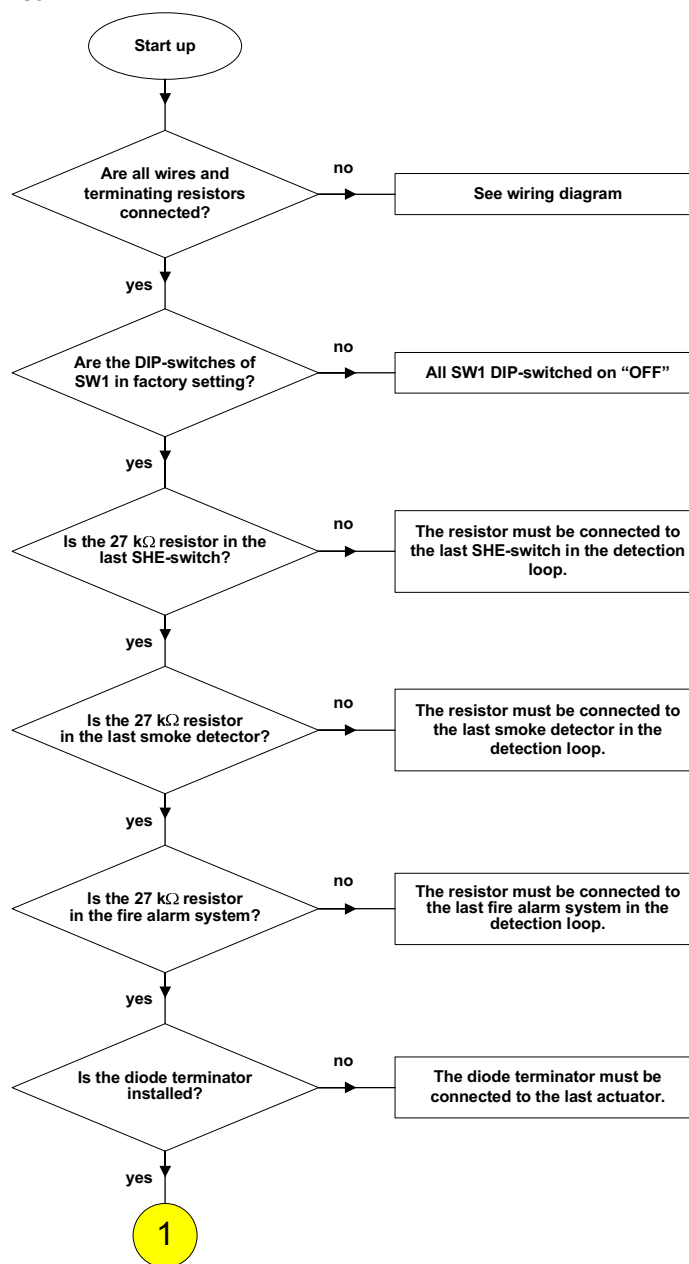

Start UP

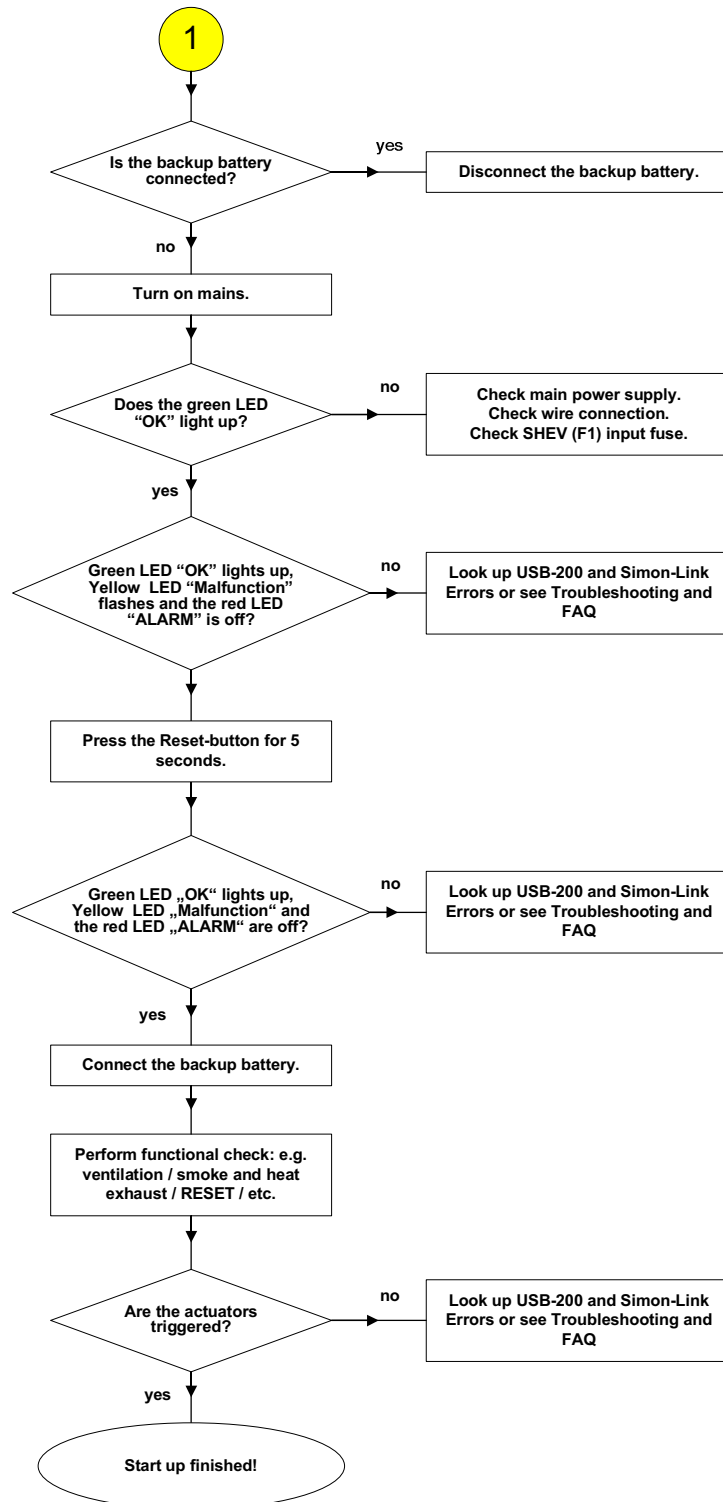

Fault Finding



ATTENTION

If mains is not permanently guaranteed after installation, there is a big risk of deep discharge of batteries! This will lead to damage to the battery.



INFO

The error message can potentially only appear after 8 minutes if the battery fails.



ATTENTION

Only batteries approved by panel manufacturer are allowed for connection. The control panel lose the relevant certifications if any other battery is used. The warranty expires.

- Connect battery plug to the port "Battery" (see Figure 15: "Battery connection").

Figure 15: Battery connection

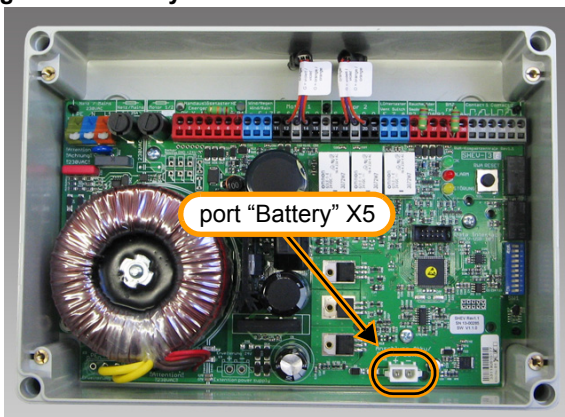

- Fasten the battery with 4 screws M4 x 8 mm (screws are included in the scope of delivery).

Figure 16: Battery fastening points

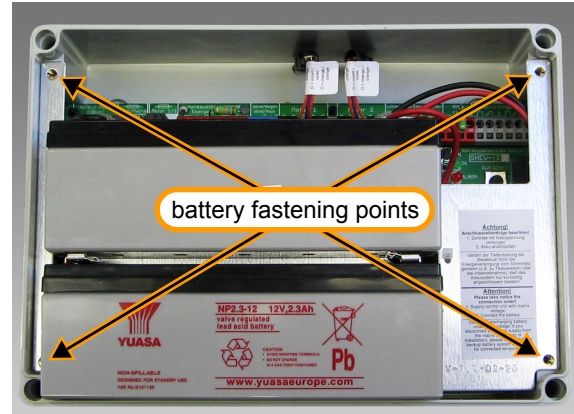

6. Fault Finding



ATTENTION

Due to the low loop current, the insulation resistance of the monitored wires (B1, B2 and B3) must be checked! The insulation resistance must be $> 20 \text{ M}\Omega/\text{km}$ (wire manufacturer specification), otherwise interruptions will no longer be detected for certain.



INFO

The operation states of the SHEV® 3 can be visualized optional by a Service Interface / cable (USB-200) (only during mains operation.) More Information: www.simon-rwa.de.



Fault Finding

6.1 Error messages

Table 3: SHEV[®] 3 fault indications

green LED on, yellow LED on, red LED off;	green LED flashes, yellow LED on, red LED off;	green LED off, yellow LED on, red LED off;	green LED on, yellow LED off, red LED on;	green LED on, yellow LED on, red LED on;	green LED flashes, yellow LED off, red LED off.
load fuse F2 defect	battery defect (High-ohmic state)	wire break motor channel 1	SHE-alarm triggered by RA input	overload, short circuit, disconnections at the outputs B1, B2, B3	system awaits 2nd reset-switch activation after SHE-alarm.
the battery reaches the deep discharge.	no battery connected	wire break motor channel 2			
	short circuit at charge output and battery connection				



INFO

The SHEV[®] 3 indications are only visualized during mains operation.

Table 4: Fault indication at the main emergency switch (HE 080 / HE 082)

green LED off, yellow LED flashes, red LED off;	green LED on, yellow LED flashes, red LED off;	green LED flashes, yellow LED flashes, red LED off;	green LED on, yellow LED off, red LED on;	green LED on, yellow LED flashes, red LED on;	green LED flashes, yellow LED off, red LED off.
emergency power operation (caused by mains power outage and under-voltage at the mains input respectively).	Load fuses defect	battery defect (high-ohmic state)	SHE-alarm triggered by RA input	overload, short circuit, disconnections at the outputs B1, B2, B3	system awaits 2nd reset-switch activation after SHE-alarm
power supply fuse F1 defect		short circuit at charge output and battery connection			
failure of the 24 V switching power supply					

Fault Finding

Table 4: Fault indication at the main emergency switch (HE 080 / HE 082)

green LED off, yellow LED flashes, red LED off;	green LED on, yellow LED flashes, red LED off;	green LED flashes, yellow LED flashes, red LED off;	green LED on, yellow LED off, red LED on;	green LED on, yellow LED flashes, red LED on;	green LED flashes, yellow LED off, red LED off.
reaching final discharge voltage by extended emergency power operation	reaching of the deep discharge voltage	no battery connected			
deep discharge voltage reached.					
wire break motor channel 1					

6.2 Troubleshooting

Table 5: Overview of errors

Malfunction	Possible Causes	Error correction
The system starts up immediately, the red LED is on and the yellow LED in the emergency button (type HE 080/082) flashes.	<ul style="list-style-type: none"> - Monitor loop not closed; - Short circuit monitor line B1, B2, B3. 	<ul style="list-style-type: none"> - Check terminating resistors HE / RM / FAS (B1, B2, B3) - Monitor loop must be closed; check voltage
The system faults, yellow LED in the emergency button (type HE 080/082) flashes.	<ul style="list-style-type: none"> - Fuses defect; - Mains power unavailable; - line termination of the motor wire defective. 	<ul style="list-style-type: none"> - Check all fuses of the control device; - Check mains connection; - Check line termination of the motor wire.
The system has AC power (green LED on) but remain in the fault mode (yellow LED flashes) and can not be reset normally.	<ul style="list-style-type: none"> - Reaches battery deep discharge; - Start up (respectively in the meantime no battery connected). 	<ul style="list-style-type: none"> - Check the battery, replace if necessary; - To reset the error messages press the reset-button for more than 5 seconds.
The motor fuse blows, yellow LED in the emergency button (type HE 080/082) flashes; the green and red LED are off.	<ul style="list-style-type: none"> - Line termination of the motor wire incorrectly connected; - F-contact of motor connected to G. 	<ul style="list-style-type: none"> - Check connection of the line termination of the motor wire. Do not connect clamp "G" with the terminal clamp "F" of the motor.
The motor has the wrong running direction.	<ul style="list-style-type: none"> - Terminal clamps "+/-" interchanged; S = blue; O = brown 	<ul style="list-style-type: none"> - Reverse the polarity of the motor at terminal clamps "S" and "O".
Ventilation switch function incorrect;	<ul style="list-style-type: none"> - connections Z, A interchanged; - potential FAS CLOSED command shuts in setting FAS; or disconnection FAS 	<ul style="list-style-type: none"> - Swap Z, A at ventilation connection.
Mains voltage 230 V AC available, no LED is on.	<ul style="list-style-type: none"> - Mains fuse F1 defect 	<ul style="list-style-type: none"> - Check fuse, replace if necessary.

Fault Finding

Table 5: Overview of errors

No current at connection "E".	- Mains fuse F1 defect - System in emergency power operation - Overload at E (ventilation switch) of > 15 mA or overload at E (WTS) of > 150 mA	- Check fuse, replace if necessary. - Check mains voltage
The motor / actuator is not working.	- Load fuse F2 defect	- Check fuse, replace if necessary.
Green LED flashes and yellow LED is on.	- Battery defect, battery high-ohmic or battery not connected	- Check battery and switch if necessary.
Failure of the +24 V power supply.	- function-failure	- Press RESET-button (> 5 seconds). Attention! If the failure still exist +24 V power supply is defect.

6.2.1 Checking voltages



ATTENTION

The components must be connected and the last component must be equipped with the terminating resistor.

Check fuses if a voltage indicates a value other than the given.

If no change happens after this, disconnect all loads and monitored loops and connect the terminating resistors and diode terminator in the SHEV® 3 to all monitored loops.

If the voltage values correspond with the specifications, then one of the connected loads is causing an overload at the connections: "E", "B1", "B2", "Y", "OK", "M" or "B3".

Connect the loads again in sequence and check the respective output voltage each time again. Subsequently check the number of the loads and faultless performance. If the voltage values still do not correspond with the given values even after disconnecting all loads, then the control panel must be checked in the factory.

6.2.2 Checking loop current

The control panel is automatically triggered if the value of monitoring current is too high or too low. Should the SHEV® 3 still be automatically triggered despite closed loops, given current, then the SHEV® 3 must be checked in the factory. Replace the used terminal resistors and diodes to make sure they are faultless.



DANGER

There is a risk of electric shock. Therefore, the tests should only be carried out by experienced and qualified personnel (The national regulations are valid).

6.2.3 Checking power supply (230 V AC 50 Hz)

Figure 17: Mains voltage

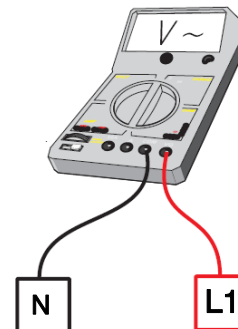

- During mains operation: approx. 230 V AC.
- Green LED "OK" on.
- Is the yellow LED "Fault" on (see Table 3: "SHEV® 3 fault indications" on page 25).

Fault Finding

6.2.4 Checking ventilation switch connection



The ventilation switch connection supplies a plus potential to the terminal clamp "E" (only during mains operation). Switching the potential to the terminal clamps "Z" or "A" results to a "CLOSED" or "OPEN" action of the connected motors. The motors stop if both terminal clamps are connected to "E".

Figure 18: Voltage ventilation switch connection

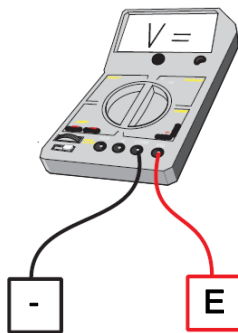

- Only during mains operation approx. 24 V.
- Should the value not be reached (see Table 5: "Overview of errors" on page 26).

6.2.5 Checking wind- / rain detector connection

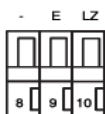

A wind/rain or a rain detector can be connected. The terminal clamp "E" provides the supply voltage for the heating and the electronics of the detector. "E" is a plus potential that is only on when the control panel is supplied with mains voltage. The operation is automatically turned off during emergency power operation.

Figure 19: Voltage wind / rain detector "E"

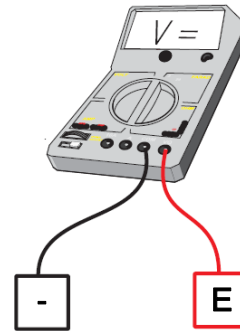

- During mains operation approx. 24 V.
- Should the value not be reached (see Table 5: "Overview of errors" on page 26).

The plus potential returns from the detector to the control panel via the connection clamp "LZ". Terminal clamps "LZ" and "Z" are ignored in the event of a triggering by the SHE-alarm. SHE has the highest priority.

The plus potential of output "E" is switched to the terminal clamp "LZ" when the detector is triggered. The control panel carries out the closing of the connected actuators. The connection takes place as per the schedule. Other detectors such as the original SIMON RWA-Systeme detectors should not be used. The wires to the detector are not monitored.

Figure 20: Voltage wind / rain detector „LZ“

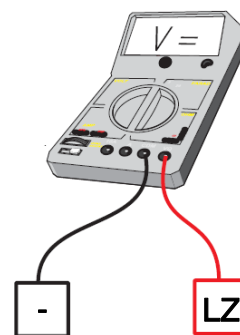

- Only during mains and triggering by "wind- / rain" approx. 24 V.

Fault Finding

6.2.6 Checking motor connection (24 V DC)



Motor output: 24 Volt DC. Defected or missing fuses will be indicated as a fault!



ATTENTION

Only fuses with a “slow” triggering characteristic should be used.

Figure 21: Voltage motor connection

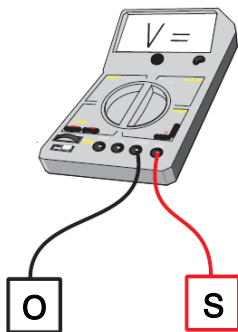

- Only during selection of “OPEN” or “CLOSED”:
- During mains operation approx. 24 V.
- During emergency power operation approx. 21 V to 28.6 V

The polarity in the terminal clamps “S” and “O” switches during selection of “OPEN” and “CLOSED”. With the switch setting “OPEN”, the terminal clamp “S” is plus potential and the terminal clamp “O” is minus potential. The monitoring loop is connected to the terminal clamp “G”. When the motor wires are faultless and the control panel is polarized in the “OPEN” direction, a closed-circuit current of 160 µA to 180 µA in the “G” wire can be measured.

The same closed-circuit current value applies to “S” and “G” for polarization in the “CLOSED”-direction.

The accompanying diode terminator must be installed at the last connection point of the motor supply wire loop as shown in the connection illustration. There will be a fault message at the main emergency switch HE 080 / HE 082 and SHEV® 3 if there is an error with the wire!



ATTENTION

There is no fault message when the diode terminator is clamped into the central unit – the motor wires, however, are not monitored.

Figure 22: Loop current motor connection

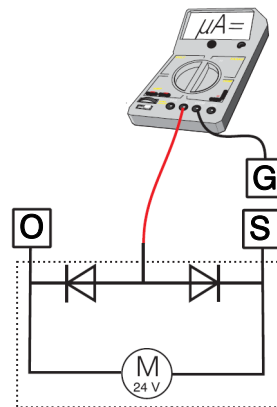

- Closed-circuit current in the wire between “G” and “purple wire” at the diode connection (monitoring loop – motor wire):
- between 160 µA and 180 µA.

6.2.7 Checking main emergency button (HE 080 / HE 082)

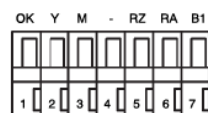

As basis for all signaling connections, the minus potential of the terminal clamp “-” applies. Terminal clamp “OK” supplies a plus potential approx. 24 V, should there be no fault with the control panel. The green LED is connected between “OK” and “-”. The connection “OK” is safeguarded by a short-circuit protection.



ATTENTION

Do not connect more than 1 main emergency switch

Fault Finding

Figure 23: Voltage at main emergency switch “OK”

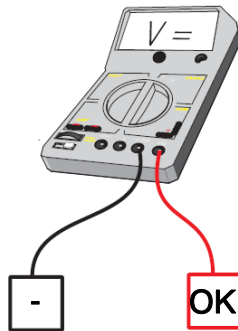

- during mains operation approx. 24 V
- during emergency power operation approx. 21 V to 28.6 V

“Y” supplies a plus potential against minus for the fault display. The signal is a continuous signal that is converted to a blinking signal by electronics on the main emergency switch. The yellow LED is connected between “Y” and “-”.

Figure 24: Voltage main emergency switch connection “Y” (fault)

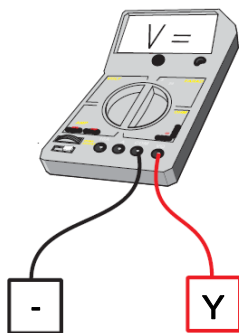

- Only during fault:
- During mains operation: approx. 24 V.
- During emergency power operation: approx. 21 V to 28.6 V.

“M” supplies a plus potential during “SHE OPEN” (HE, RM, TH, FAS). The red LED alarm is connected between “M” and “-”. This output can service max. 8 OPEN-displays of the control units in parallel. If more than 8 switches are connected, the voltage value at output “M” breaks down to an undefined value.



ATTENTION

Never connect more than one main (HE 080 / HE 082) and 7 off site emergency buttons (HE 081).

Figure 25: Voltage main emergency switch “M” (Alarm)

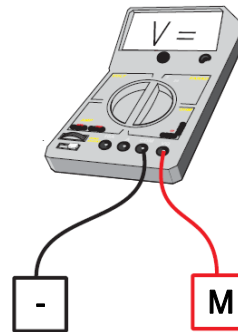

- Only during SHE-alarm:
- During mains operation: approx. 24 V.
- During emergency power operation: approx. 21 V to 28.6 V.

“B1” supplies the plus potential for the closed-circuit current loop, which monitors the switch wires of the emergency switch HE 080 / HE 082. The closed-circuit current window lies between 50 µA and approx. 5 mA. If the value of the closed-circuit current is not within this tolerance, the control panel is triggered. The terminating resistor must be looped in at the last switch wire connection point as marked in the schemes. The loop is monitored for disconnection and short circuit. If no switches are connected, the resistor must be directly installed in the control panel (SHEV[®] 3) (delivery state).

Figure 26: Voltage main control unit connection “B1”

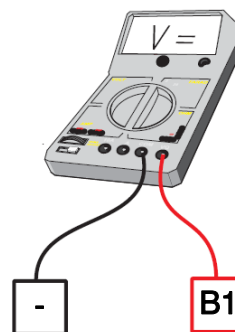

Fault Finding

➤ During mains and emergency power operation: approximately 18 V.



ATTENTION

If the terminal resistor remains in the control panel, the manual control device (HE 080 / HE 081 / HE 082) only allows triggering by "RA". Loop monitoring does not take place!

Figure 27: Closed-circuit current main emergency button connection "B1"

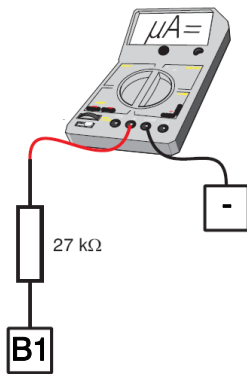

➤ 600 μ A to 700 μ A

By clamping the potential of terminal connector "B1" onto terminal connector "RZ", a RESET of the system is effectuated.



INFO

The SHEV® 3 is equipped with a reset function (see chapter 1.5.8 "SHE-switch reset function" on page 12).

6.2.8 Checking smoke detector connection

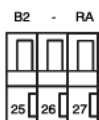

Similar to terminal clamp "B1", terminal clamp "B2" supplies a plus potential that, with the terminal resistor switched against minus, results in a defined closed-circuit current loop. The terminal resistor closes the loop at the last smoke detector (see Figure 11: "Wiring diagram smoke detector" on page 21). Only smoke detectors of the type RM 3000 or RM 2860 should be connected. If no smoke detectors are connected, the terminal resistor will be directly clamped in the control panel (delivery state). In standard wiring, RA is without function.

Figure 28: Voltage main control unit connection "B1"

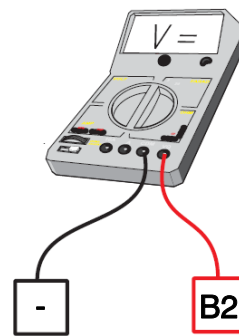

➤ During mains and emergency power operation: approx. 18 V.



ATTENTION

If the terminal resistor remains in the control panel, loop monitoring does not take place!

Figure 29: Loop current smoke detector connection

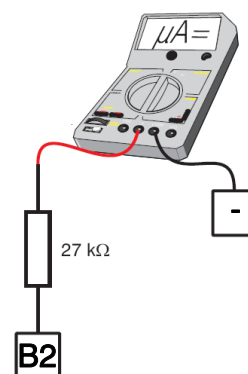

➤ 600 μ A to 700 μ A

Fault Finding

6.2.9 Checking output for an on-site SHE release contact (for example Fire alarm)

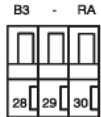

The output for a on-site contact (N/C contact) is achieved by the terminal clamps “B3” and “-”. The monitoring concept is identical to the other monitoring loops of the “B1” and “B2” outputs. For example, a heat detector with volt-free N/C contact can be connected to the output “B3” (see Figure 12: “Wiring diagram contact FAS” on page 21). If no contacts are connected, the terminal resistor will be directly clamped in the control panel (delivery state!).



ATTENTION

If the terminal resistor remains in the control panel, loop monitoring does not take place!

Figure 30: Voltage on-site SHE triggering contacts (e. g. FAS)

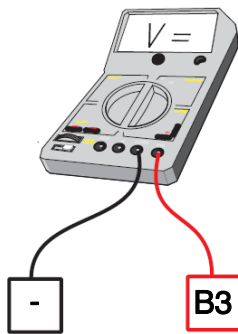

↳ During mains and emergency power operation: approx. 18 V.

Figure 31: Loop current on-site SHE triggering contacts (e. g. FAS)

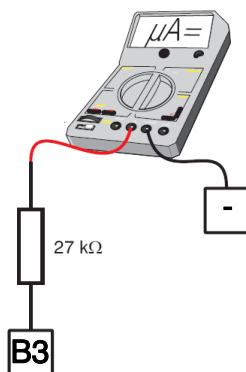

↳ 600 µA to 700 µA

Fault Finding

6.3 FAQ — Frequently Asked Questions

- Question: Why is there still an error message despite inserting and connecting of the battery and placing of the main power line?
 - Answer: To take the control unit (including emergency power supply) into operation you must press the RESET-button for more than 5 seconds.

- Question: Why does the yellow LED (common fault) lights, although all recognizable and known causes have been eliminated?
 - Answers:
 - » 1. The maintenance counter is expired and must be set back, via SIMON-link.
 - » 2. Battery deep discharge: If the error-message can not be set back by pressing the RESET-button for more than 5 seconds the battery must be replaced.

- Question: Why do I not get a fault indication when the battery is not plugged in or the connection cables are disconnected? (yellow LED???)
 - Answer: The battery assessment is carried out in cycles and can last up to maximum 8 minutes. In the event of a battery fault, the yellow LED is set and additionally the green LED is turned flashing for better distinction. The malformation “Battery defect or not connected” goes out without time delay.

- Question: Battery change with or without metal plate?
 - Answer: The battery pack can be changed entirely and is available as a replacement set from the factory. On site unapproved batteries render the warranty invalid.

- Question: What does the VDS-number on the battery means? Is this a special SHE-number?
 - Answer: The VDS number on the battery is also suitable for use in the SHE-area.

- Question: Why does the yellow LED in HE 080 / HE 082 flash constantly during SHE-triggering?
 - Answer: The flashing of the yellow LED during SHE-alarm at the main emergency button HE 080 / HE 082 is initiated by the switch itself and can not be changed.

- Question: Why does the safe opening / closing not work during emergency power operation?
 - Answer: The initiated OPEN or CLOSED action of the function “secured closing” and opening of the smoke vents is only completed with a change to emergency power operation. When the system is in emergency power operation, the ventilation switch is disabled and the smoke-vents can only be operated by the SHE-alarm opened.

- Question: What is the terminal clamp No. 16?
 - Answer: The terminal clamp 16 is unassigned and does not have any function in the current software status.

- Question: Which protection type: IP 54 or IP 66?
 - Answers:
 - » 1. The housing offers protection type IP 66. The protection type does not change with cable glands of protection type IP 66.
 - » 2. Cable glands of protection type 54 reduce the overall protection type to IP 54.

Care and Maintenance

7. Care and Maintenance



ATTENTION

The performance of the system must be tested regularly by the operators. The manufacturer must be informed as soon as possible in case of a potential defect. Defected parts are to be replaced immediately.



DANGER

Smoke and heat exhaust vent systems serve the protection of human lives and must therefore be maintained regularly – at least once a year – by a specialised company authorised by the manufacturer. The maintenance work carried out is to be documented.

The maintenance must be performed according to a checklist to be procured from the manufacturer.



ATTENTION

For maintenance purposes of the emergency power supply, the installed batteries must be regularly tested and replaced by new batteries if necessary.

You have the option to purchase the battery pack as a complete replacement set. Please contact the manufacturer or the distributor.

7.1 Environmental note



ENVIRONMENTAL NOTE

The control units are recyclable and must not be disposed of in the residual waste. According to the disposal law "ElektroG", this device must be disposed properly at the end of its life time. Please contact your waste disposal company if you have any questions.



ENVIRONMENTAL NOTE

Used batteries must not be disposed of in the residual waste. The batteries must be disposed properly at the end of their life time. Please contact your waste disposal company if you have any questions.

7.2 Repair and exchange



DANGER

The control unit must not be used if repair or adjustment work needs to be carried out. The system must be disconnected on all poles from the mains and emergency current supplies before performing cleaning or other maintenance work.

The control unit may be repaired only by the manufacturer. The control unit must be replaced in the case of a fault of defect.

7.3 Warranty terms

The product must be used as normally intended. The product is subject to natural wear and tear. In case of material defect claims, these shall be asserted in writing, stating the source of supply of the device. The following applies with respect to the guarantee: "General conditions for the supply of products and services of the electrical and electronics industry ("Green delivery terms" – GL)". These can be found at our homepage www.simon-rwa.de. We would be pleased to send you a copy upon request.

Appendix

8. Appendix

8.1 Manufacturer's declaration



We hereby declare the conformity of the product with the applicable guidelines. The declaration of conformity can be viewed in the company and will be delivered upon request. This declaration certifies conformity with the directives mentioned, but gives no guarantee of characteristics. This declaration becomes invalid following a change that has been made without our consent.

8.2 EC manufacturer's declaration (distributor)

The installer is responsible for the proper mounting or commissioning and the preparation of the declaration of conformity in accordance with the EU directives.



INFO

The installer is responsible for affixing the CE marking. The CE-marking is to be affixed in a visible place!

8.3 Company addresses

8.3.1 Germany

Simon RWA[®] Systeme GmbH
Medienstr. 8
D – 94036 Passau
Tel: +49 (0)851 98870 - 0
Fax: +49 (0)851 98870-70
E-mail: info@simon-rwa.de
Internet: www.simon-rwa.de

8.3.2 Switzerland

Simon RWA[®] Systeme AG
Allmendstrasse 8
CH – 8320 Fehraltorf
Tel: +41 (0)44 956 50 30
Fax: +41 (0)44 956 50 40
E-mail: info@simon-rwa.ch
Internet: www.simon-rwa.ch

8.3.3 Hungary

Simon RWA[®] Systeme Kft.
Vezér utca 147 / D, 3rd Floor, No. 17
H – 1149 Budapest
Tel: +36 (0)44 822 12 52
Fax: +36 (0)44 822 12 03
E-mail: info@simon-rwa.com

BA SHEV-3 ST4-3140 EN 1.1

General Conditions of Business and Terms of Delivery

The currently valid conditions for products and services of the electrical and electronics industry (green delivery terms) apply for deliveries and services, including the supplementary clause "Extended retention of title". These are published by ZVEI Frankfurt. If you are not familiar with these, we would be happy to send them to you. The agreements are also available for download at www.simon-rwa.de.

Passau is the established legal venue.

Your **Simon RWA** partner: